

ALZADO LATERAL ESTRUCTURA
ESCALA 1/100

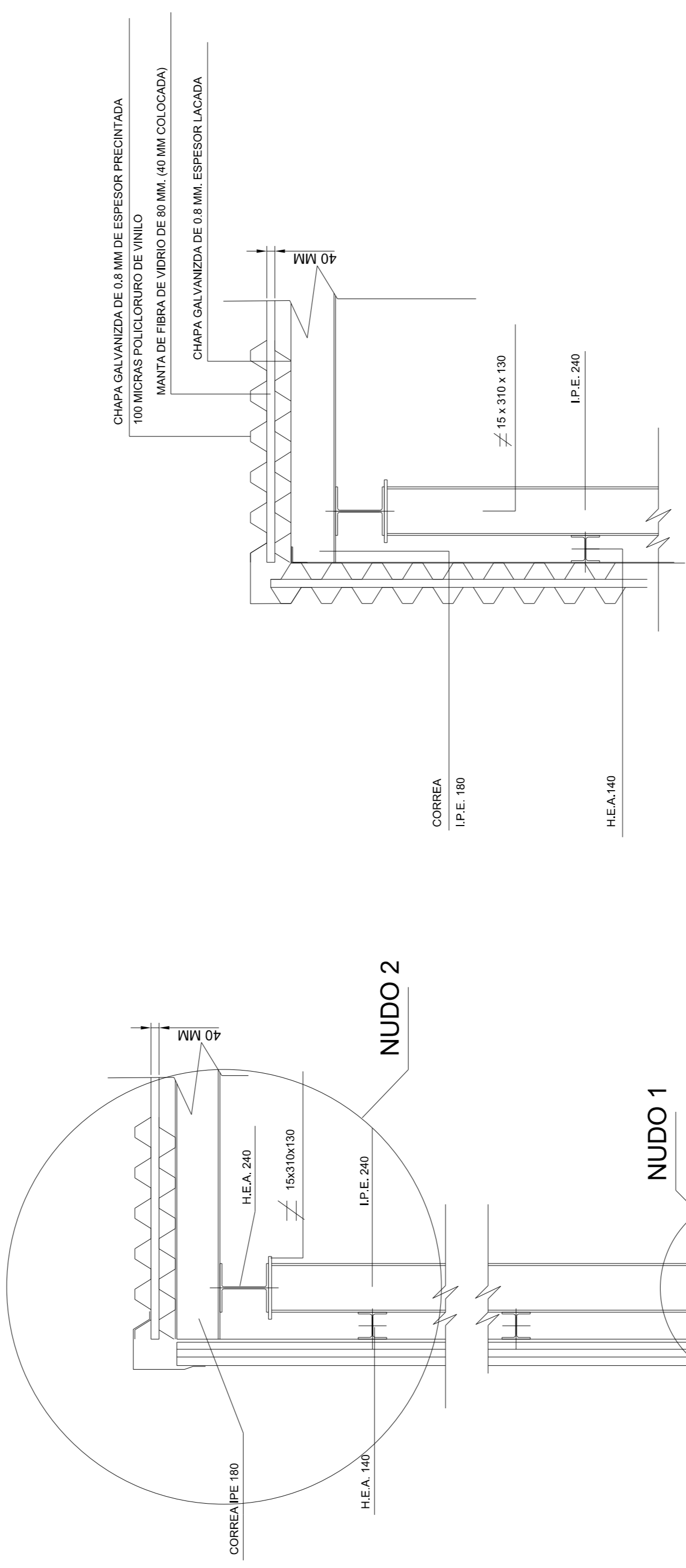

ALZADO
ESCALA 1/20

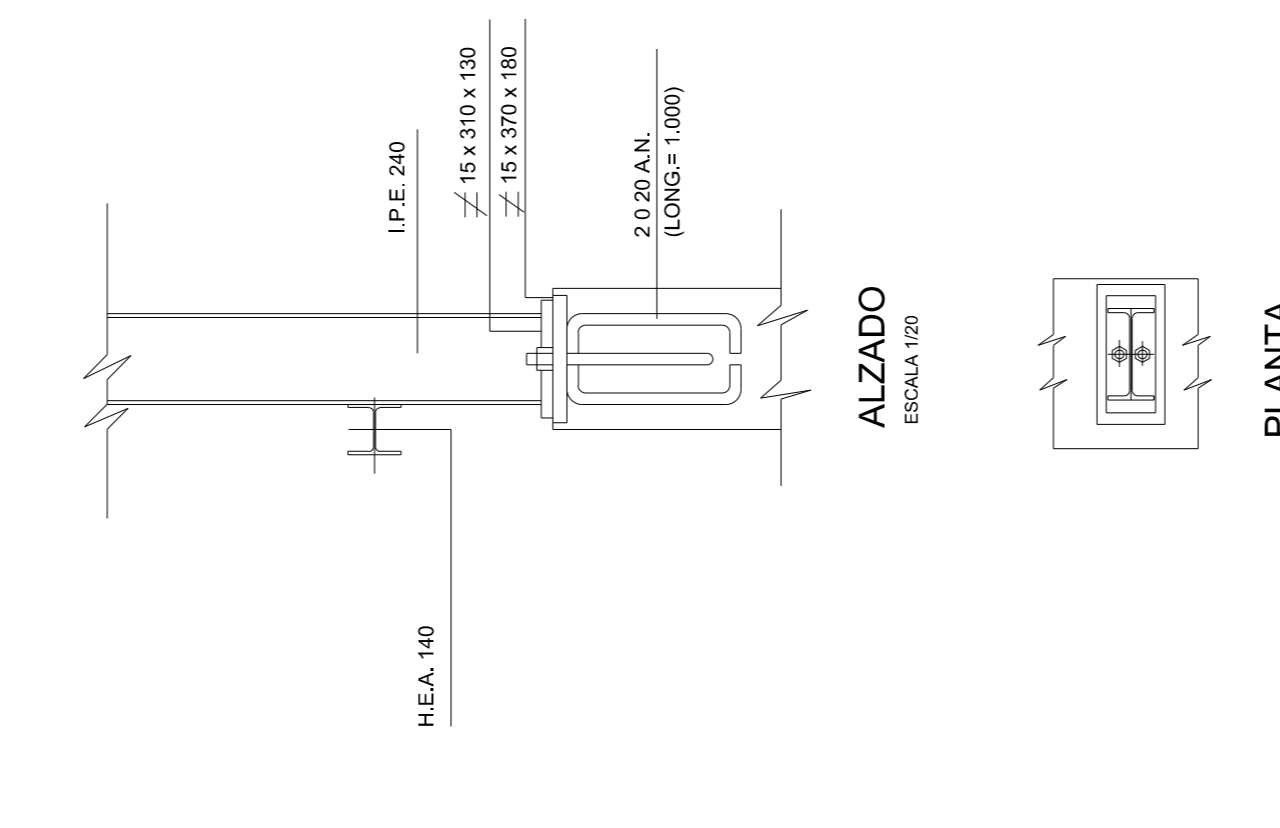

NUDO 1
ESCALA 1/20

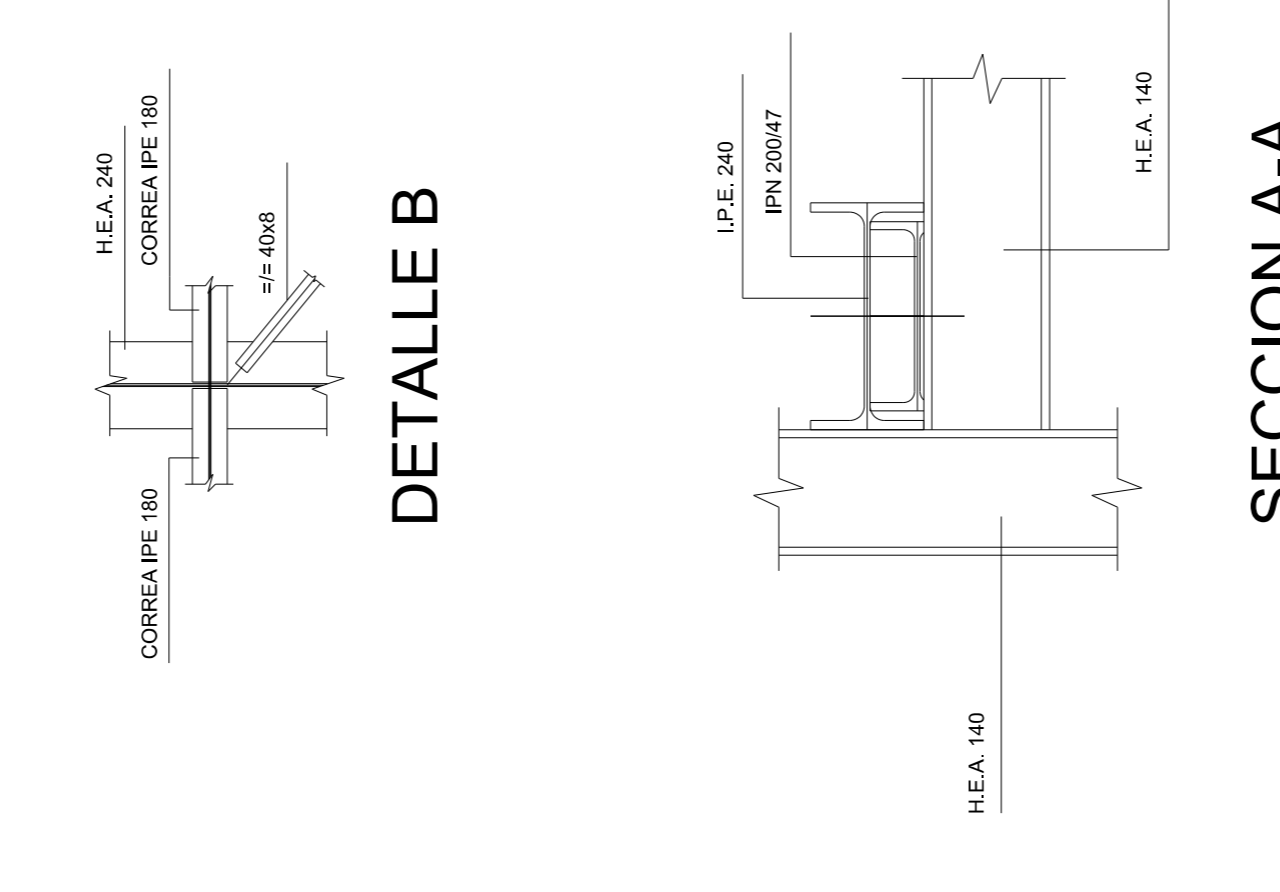

NUDO 2
ESCALA 1/20

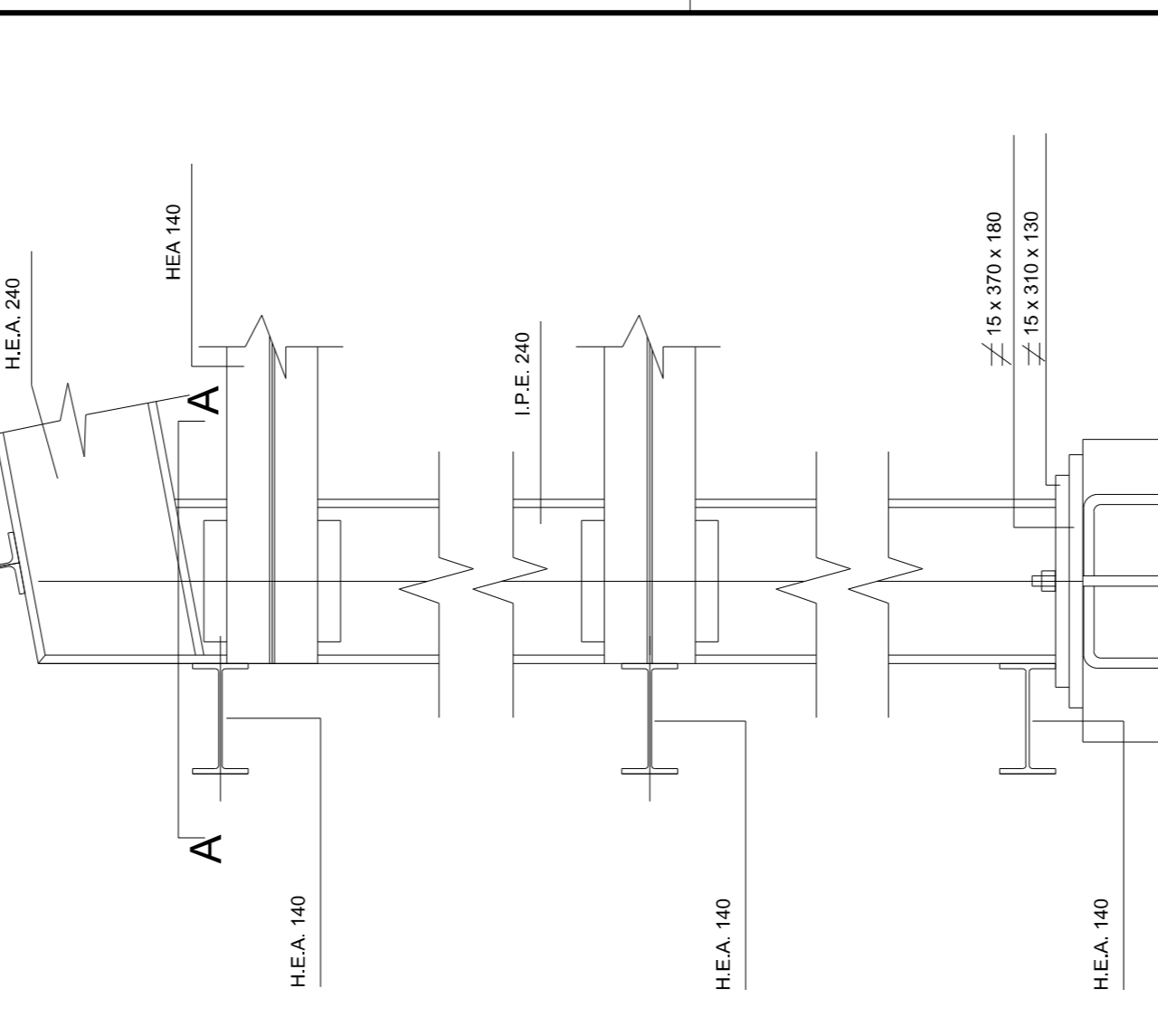

SECCION A-A

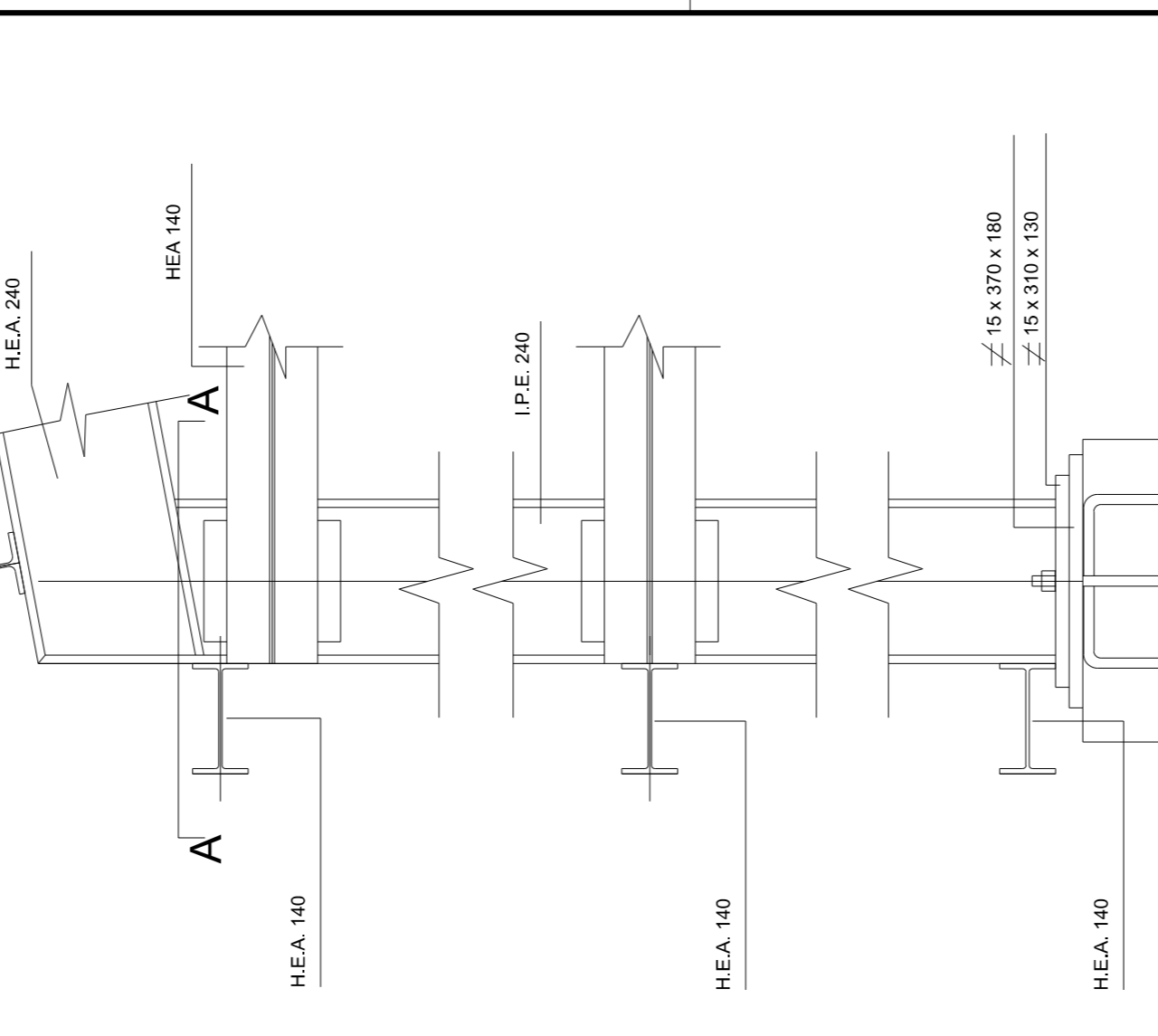

DETALLE A

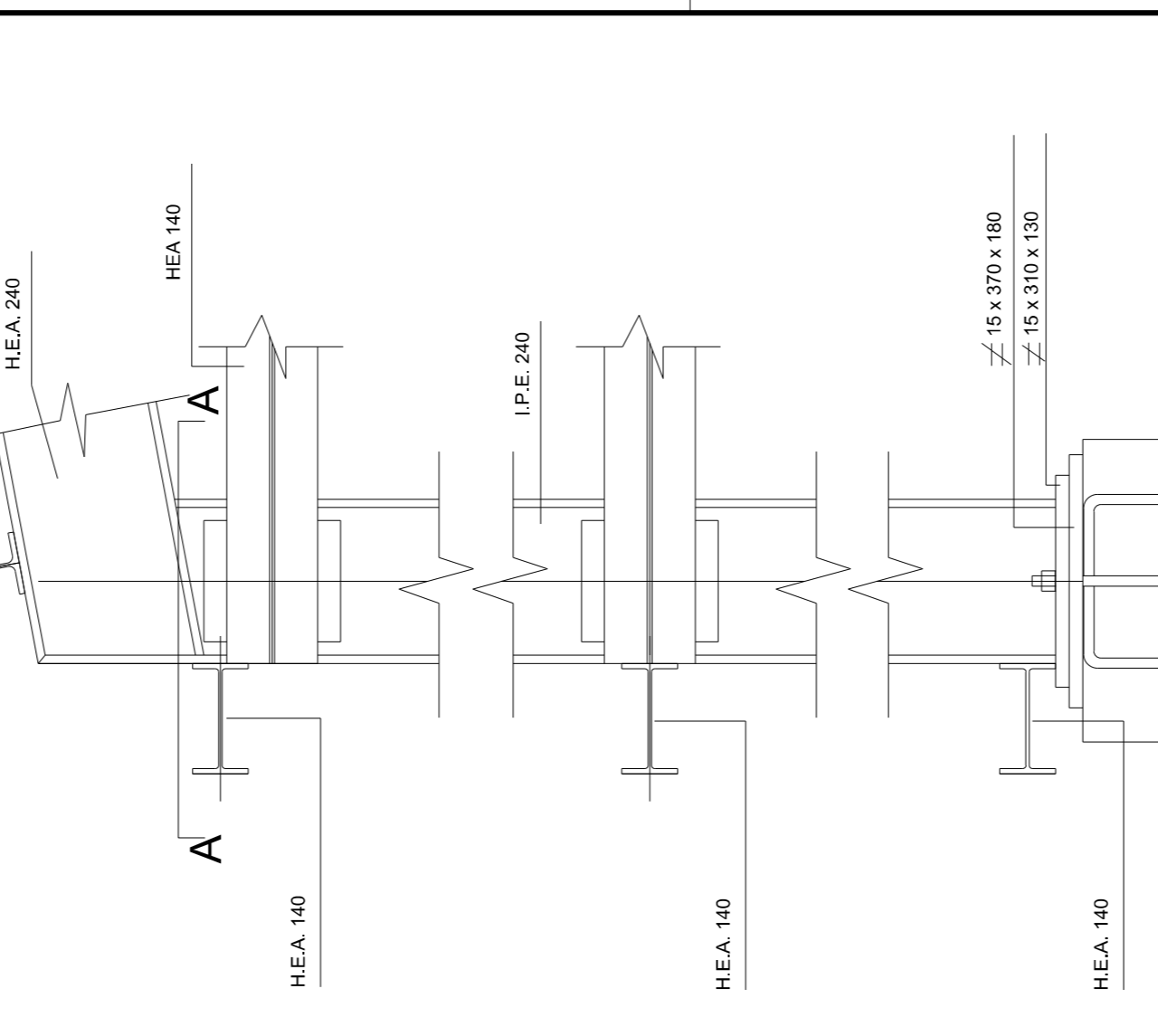

DETALLE B

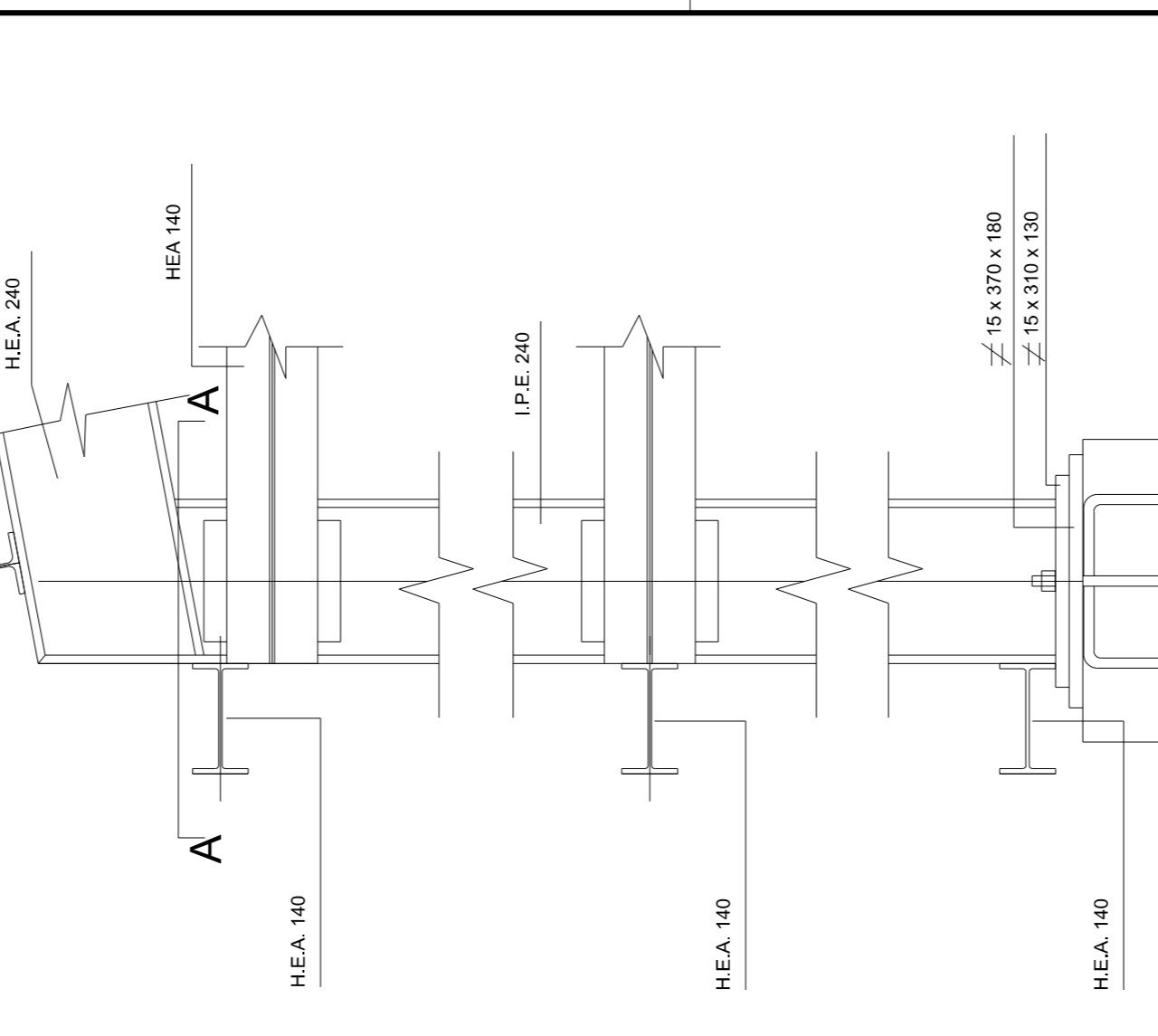

DETALLE C

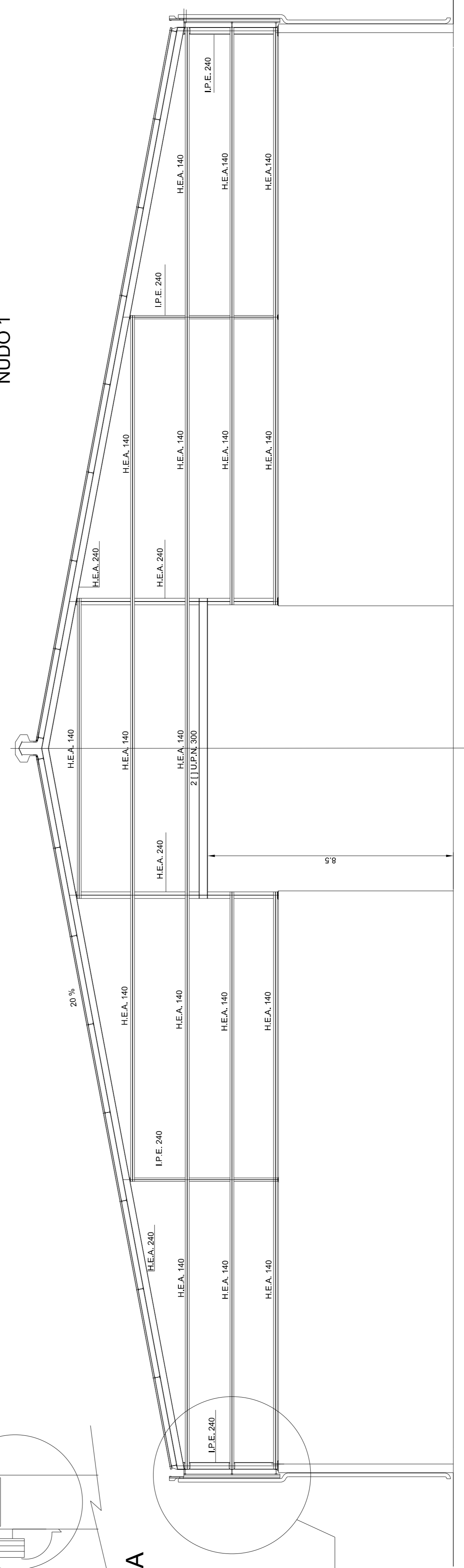

ALZADO FRONTAL ESTRUCTURA
ESCALA 1/100

DETALLE-A

DETALLE B

DETALLE C

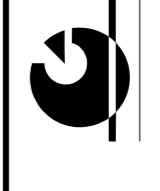

Puerto de Gijón
Autoridad Portuaria de Gijón

LIQUIDACION PROVISIONAL DE LAS OBRAS DEL PROYECTO DE
TINGLADO Nº2 EN LA FIGAR

FIGARON Nº:	6	ESCALA:	INDICADAS
DE DENOMINACION:	DETALLES DE ALZADOS LATERAL Y FRONTAL ESTRUCTURAS	FECHA:	OCTUBRE 2001
EL JEFE DE DIVISION DE CONSERVACION Y CONSERVACION:		CONFORME EL CONTRATISTA:	